

SILVERFOX



2270FB

FACIAL CHAIR



- TEL: 0086-750-2633320 2633805
- sales@silverfox.cn / www.silverfoxgp.com
- No.18,1st TongLe Road,TangXia Town,
PengJiang District,JiangMen City,GuangDong Province,China

CE

FDA



RoHS

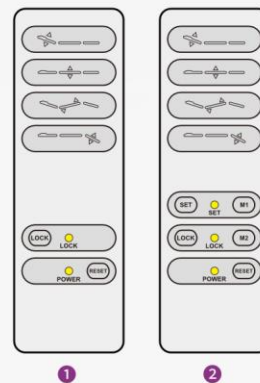

2270FB / 4 motors

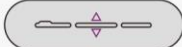

Hand Remote 1 Options 2 Memory Function is optional

-  * Backrest Adjustment
-  * Lifting Adjustment
-  * Seat Tilt Adjustment
-  * Footrest Adjustment
-  * LOCK
-  * RESET
-  * Memorizing Position Setting 1
-  * Memorizing Position Setting 2



Comfortable Upholstery

With waterproof and skin-friendly upholstery, no stitch on the upholstery, feeling is more comfortable.

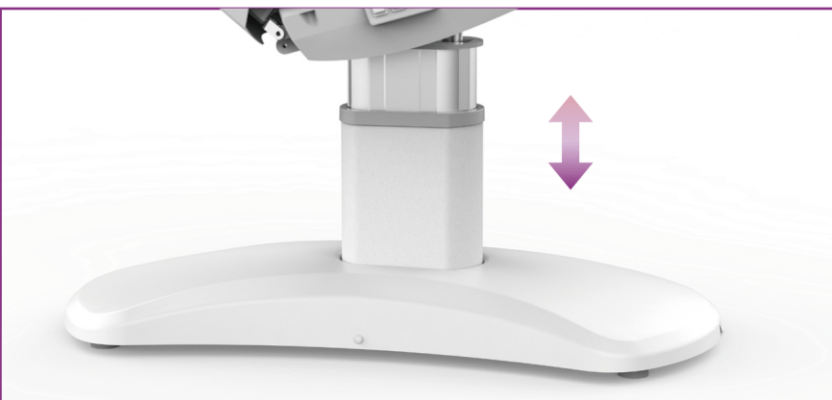

Single Column Lifting

Design is simple and modern, saving space for operators.



Linkage Armrest

No matter how much the backrest angle is, the armrest and the cushion always remain parallel to improve comfort when treatment.

※Standard Configuration



Max Load Bearing

※Options



Hand Remote



Heating



Silicone Sponge /Memory Foam



Foot Controller



Memory System

※Technical Parameters

Model	Product	Voltage	Frequency	Power Rating	Warranty
2270FB	Facial Chair	AC 100-120V AC 220-240V	50/60Hz	300W	2 years (Motors and Control Box: 3 years)

※Specifications

- Max load bearing : 175 kg / 386 lbs
- Gross weight : 85 kg/188 lbs
- Package size :
- Product size(L*W*H) : 1920x760x585/805 (mm)
- Net weight : 75 kg/166 lbs
- 1700x630x620 (mm)≈0.67m³

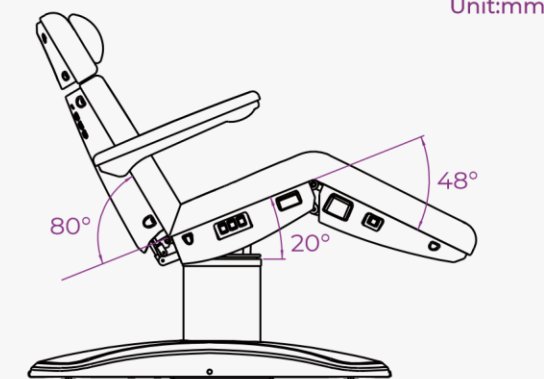
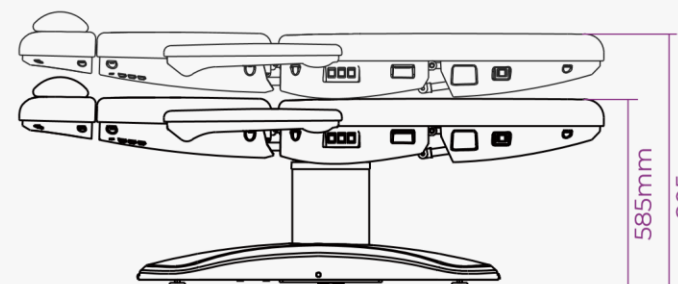

Unit:mm